

GENERAL PURPOSE, 1/3R, COLOR: WHITE.

FOR SCHEMATIC SEE DWG# 26941

APPROX WT: 570LBS

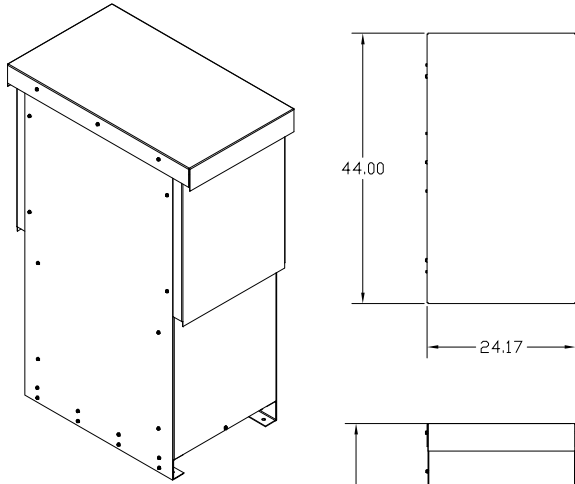

PART NUMBER: KMG200CG3R0000

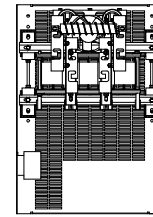

T1 T2 T3

U V W

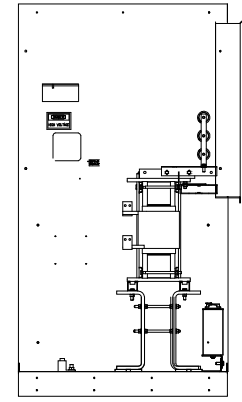
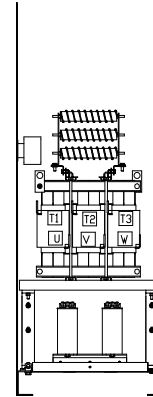
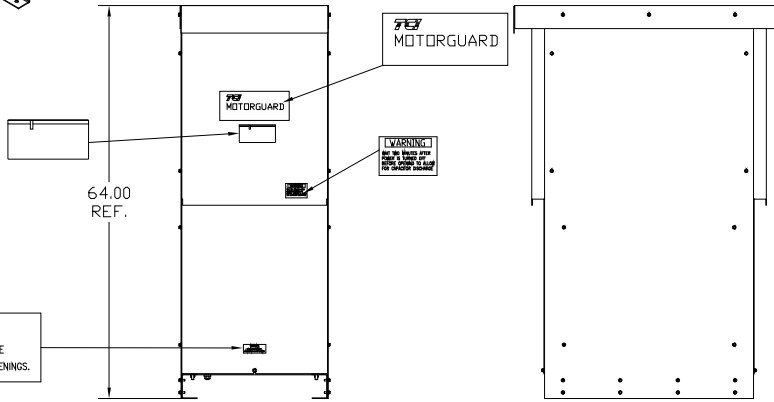
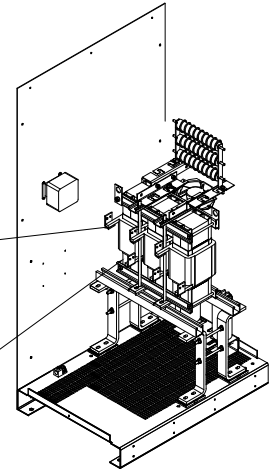

WARNING
DO NOT PLACE FLAMMABLE MATERIALS NEAR EXHAUST OPENINGS.

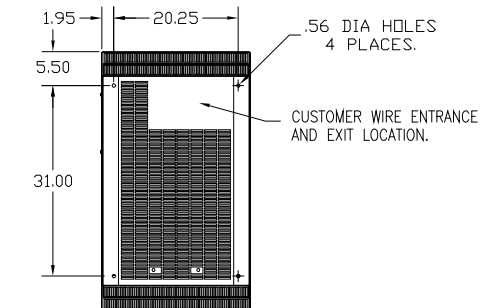

KMG HIGH PERFORMANCE OUTPUT FILTER

PART NUMBER: KMG200CG3R0000
 FLA: 200 DRAWING#: 103928DG
 SYSTEM VOLTAGE: 600V SCHEMATIC: 26941
 HZ: 80
 PHASE: 3 ENCLOSURE TYPE: 1/3R

MOTORGUARD

CUSTOMER IS RESPONSIBLE FOR INSTALLATION TO MEET ALL NATIONAL AND LOCAL ELECTRICAL CODES.

TOLERANCES UNLESS OTHERWISE SPECIFIED			V132 N10611 GRANT DRIVE GERMANTOWN, WI 53022 KMG, LRC FILTER, STANDARD 200AMP, 600/3/80, 1/3R REV: 1/28/09 BY: D 103928DG
XX	± .50	DATE	
XXX	± .25	BY	
A	3251 TOP WAS 48"	1/6/15	BVM
NO	REVISION	DATE	BY