

CATALOG NO	VOLTAGE	NEC MOTOR HP	NEC MOTOR CURRENT	WATTS LOSS	APPROX. WEIGHT-LBS	TORQUE (LB-IN)
KDRULD33PE3R	575	30	32	SEE NOTE: 1	27	20

NOTE: A1, A2, B1, B2, C1, C2, MARKINGS ON TERMINAL BLOCK FOR REFERENCE ONLY.

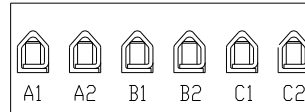

TERMINAL BLK MARKING

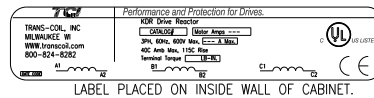

NOTE 1: WATTS LOSS WILL VARY DUE TO FUNDAMENTAL FREQUENCY, CARRIER FREQUENCY AND OTHER SYSTEM CHARACTERISTICS.
 KDR DRIVE REACTORS COMPLY WITH THE THERMAL AND ALTITUDE STANDARDS SET FORTH BY NEMA ST20-1992..

NEC MOTOR CURRENTS SHOWN IN THE 208/240 VOLT CHART ARE BASED ON HORSEPOWER AT 208 VOLT. 575/600 VOLT CHART USE THE 575 VOLT CURRENT RATING.

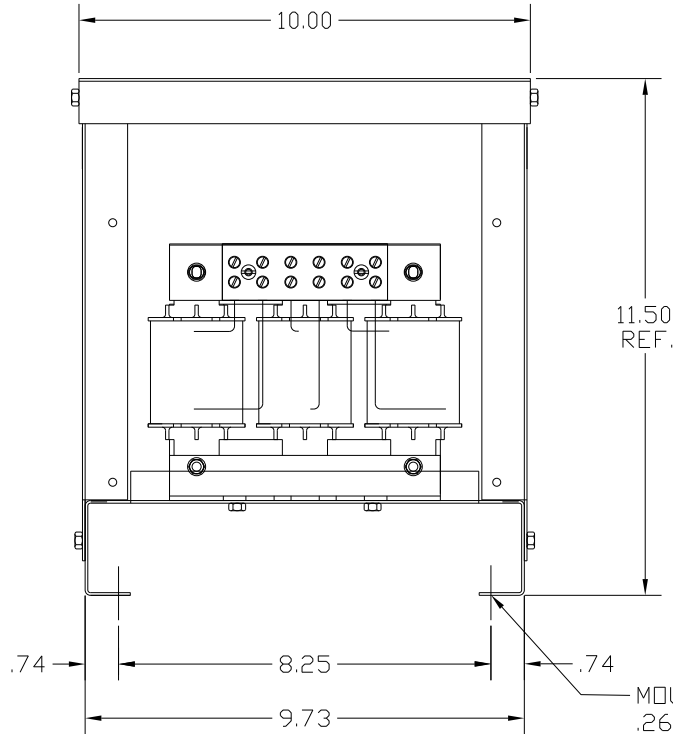

MOUNTING
 .265 DIA HOLES
 4 PLACES

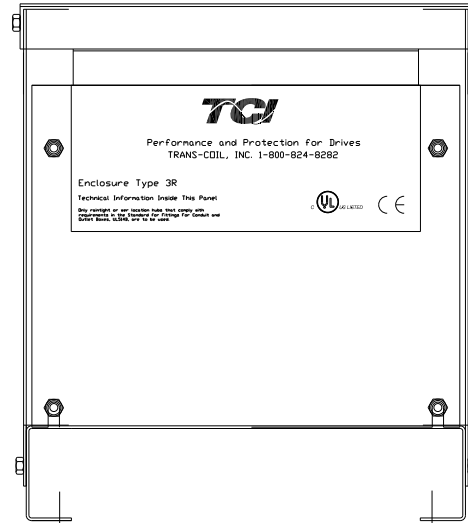

CUSTOMER IS RESPONSIBLE FOR INSTALLATION TO MEET ALL NATIONAL AND LOCAL ELECTRICAL CODES. .50

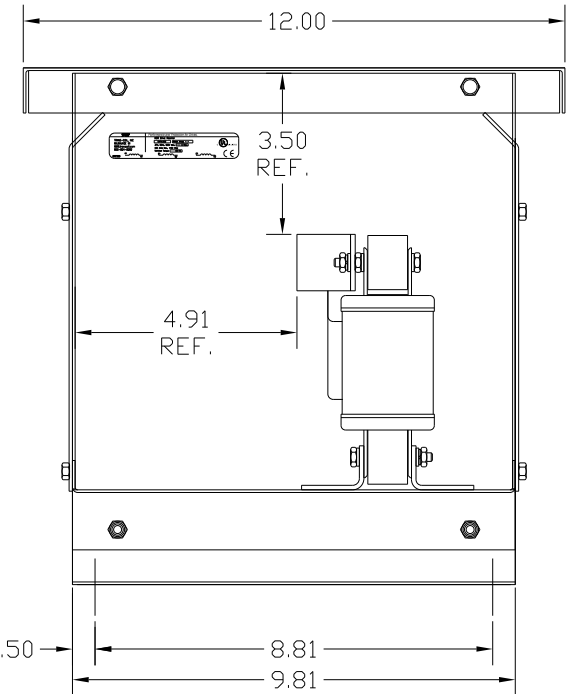

NOTE: USE ONLY HUBS OR FITTINGS THAT COMPLY WITH UL514B FOR TYPE 3R ENCLOSURES.

FINISH:
 VENDOR - LILLY POWDER COATINGS, INC.
 PRODUCT CODE - 312E
 COLOR - PEBBLE GRAY
 POWDER TYPE - POLYESTER-POLYURETHANE

PAINT SUITABLE FOR OUTDOOR APPLICATION PER UL TYPE 3R AND APPLIED PER A UL ACCEPTED DTVV2 COATING PROGRAM.

NO	REVISION	DATE	BY

TCI 7878 N. 86th STREET
 MILWAUKEE, WI 53224

KDR OUTPUT REACTOR
 575V, ENCLOSED, TYPE 3R

DRN. BY DSW DATE 9/20/04 DWG. NO. KDRULD33PE3R.DWG
 SCALE APRVD. SH. 1 of 1