

CATALOG NO	VOLTAGE	NEC MOTOR HP	NEC MOTOR CURRENT	WATTS LOSS	APPROX WT-LBS
KDRA44HC1V	690	3.0	3.9	35	8

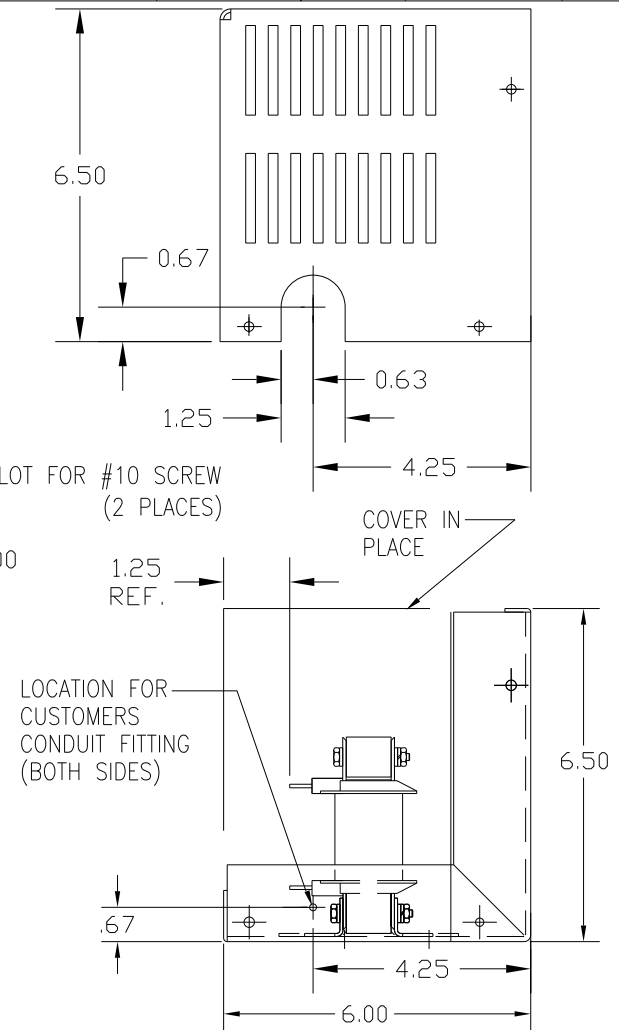
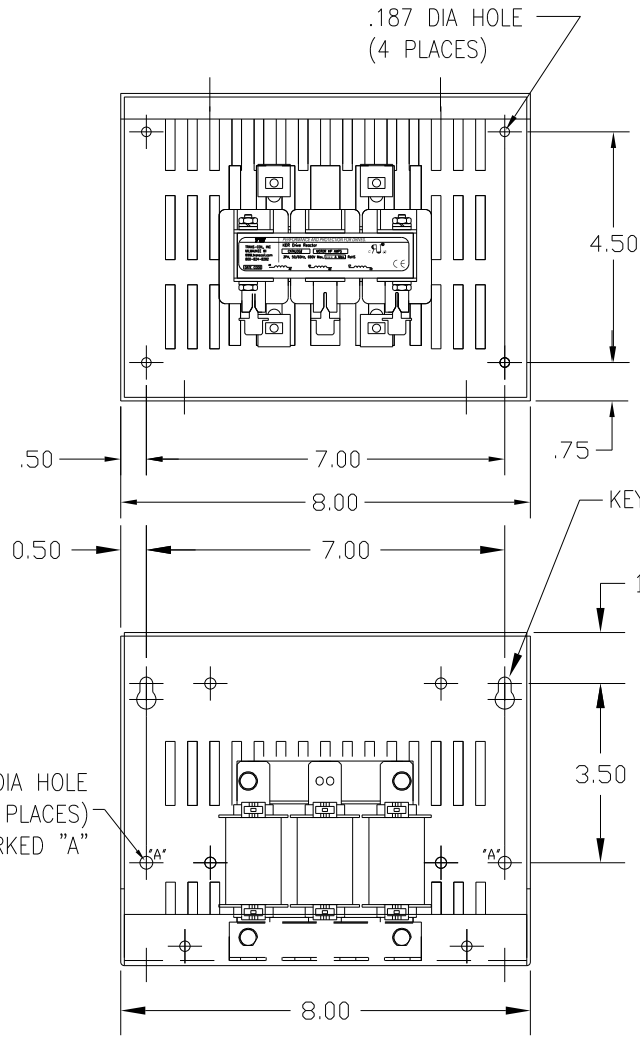
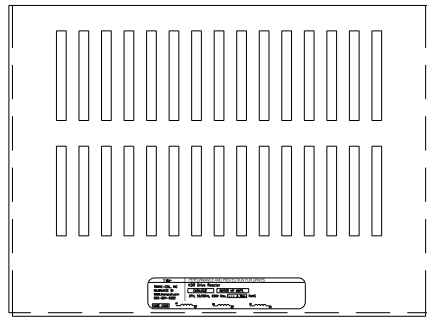

CUSTOMER IS RESPONSIBLE FOR INSTALLATION TO MEET ALL NATIONAL AND LOCAL ELECTRICAL CODES.

				TOLERANCES (EXCEPT AS NOTED)		7878 N. 86th STREET MILWAUKEE, WI 53224	
				DECIMAL		KDR DRIVE REACTOR, ENCLOSED	
				.XX ± .03		690V HIGH Z, FRAME A	
				.XXX ± .01		DRN. BY DSW DATE 2/15/12 DWG. NO. B	
				FRACTIONAL		APRVD. B	
				± 1/32		KDRA44HC1VDG	
				ANGULAR		SHT. 1 OF 1	
				± 1/2°			
NO	REVISION	DATE	BY	SCALE			