

CATALOG NO	VOLTAGE	NEC MOTOR HP	NEC MOTOR CURRENT	WATTS LOSS	APPROX WT-LBS	TORQUE (LB-IN)
KDRA3HC1	480	5.0	7.6	80	9	10

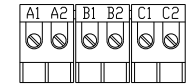

NOTE: A1, A2, B1, B2, C1, C2, MARKINGS ON TERMINAL BLOCK FOR REFERENCE ONLY.

BLOCK WIRE RANGE	#12-#18 AWG
TIGHTENING TORQUE.	10 LB-IN

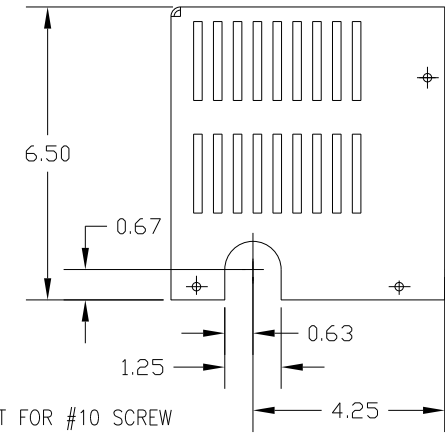
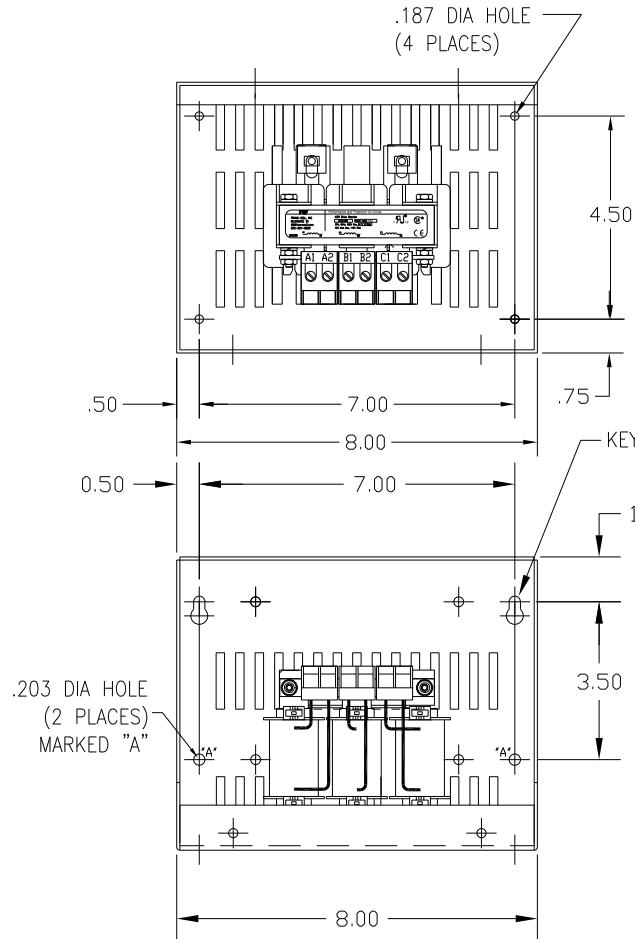
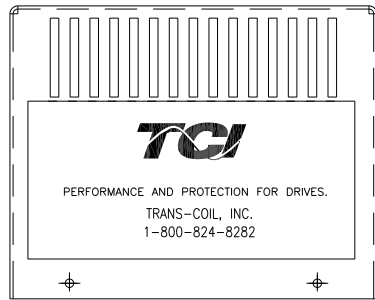
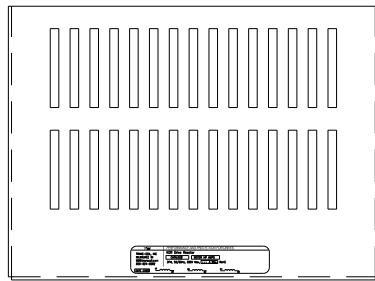
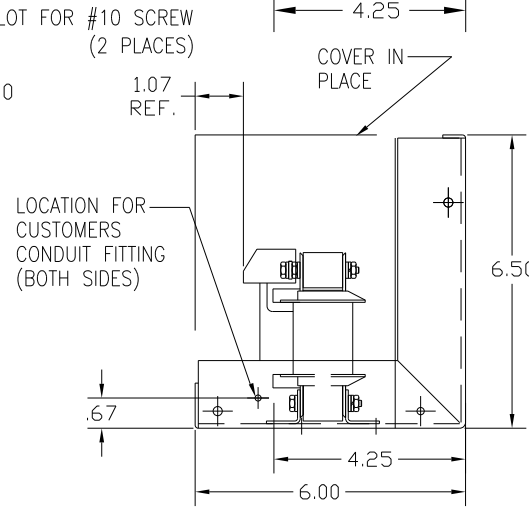

CUSTOMER IS RESPONSIBLE FOR INSTALLATION TO MEET ALL NATIONAL AND LOCAL ELECTRICAL CODES.

NO	REVISION	DATE	BY	TOLERANCES (EXCEPT AS NOTED): DECIMAL .XX ± .03 .XXX ± .01 FRACTIONAL ± 1/32 ANGULAR ± 1/2°	 7878 N. 86th STREET MILWAUKEE, WI 53224 KDR DRIVE REACTOR 480V HIGH Z, FRAME A DRN. BY: DSW DATE: 1/25/12 DWG. NO.: KDRA3HC1DG SCALE: APRVD: B SHT. 1 OF 1