

SEE DWG# 26964-1 FOR SCHEMATIC

CUSTOMER IS RESPONSIBLE FOR INSTALLATION
TO MEET ALL NATIONAL AND LOCAL ELECTRICAL CODES.

NOTE: USE ONLY HUBS OR FITTINGS THAT COMPLY
WITH UL514B FOR TYPE 3R ENCLOSURES.

UNIT SPECIFICATIONS:					
KVAR	HARMONIC	VOLT	HZ	PHASE	HP
120	5TH	600	60	3	400
ENCLOSURE		TYPE 3R- COLOR, WHITE			
FEATURES		CONTACTOR			
APPROX.WT. LBS		976			

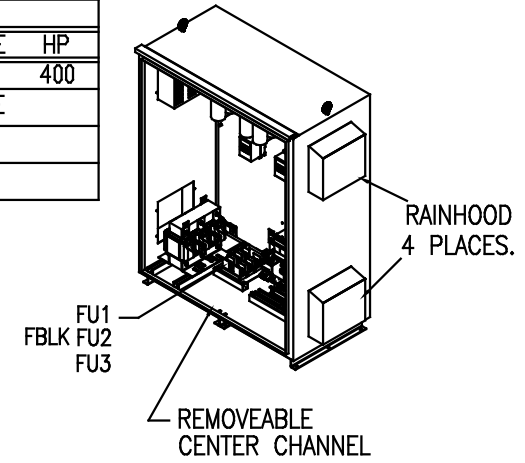
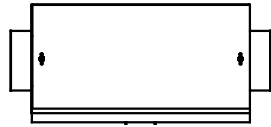
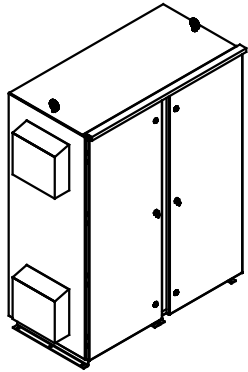

INSIDE
DOOR

SIDE VIEW

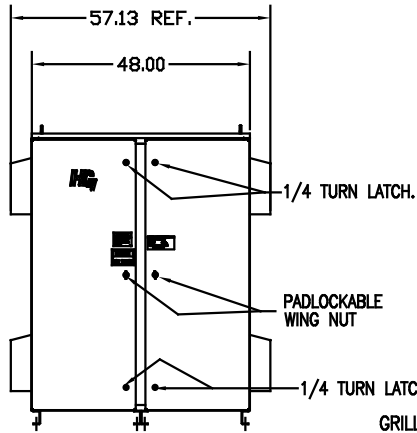
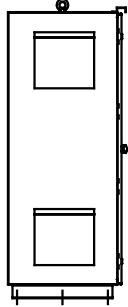
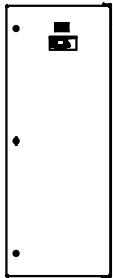

FRONT VIEW
WITH DOORS.

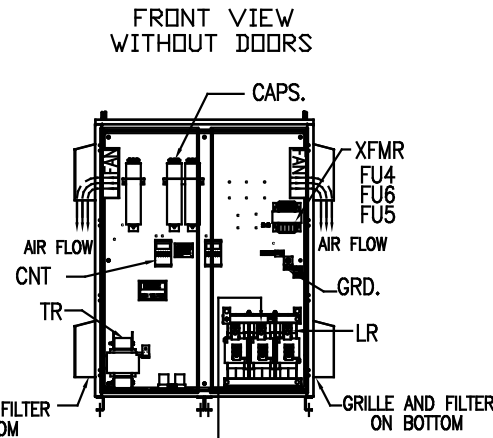

FRONT VIEW
WITHOUT DOORS

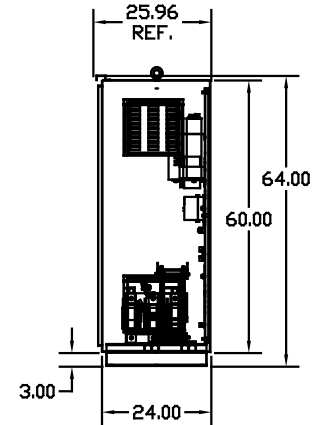

SIDE VIEW

.50 DIA HOLES
12 PLACES.

GROUND LUG:
WIRE RANGE-TWO 350MCM-4
TIGHTENING TORQUE 275 IN-LB.

L1 L2 L3 T1 T2 T3
SUGGESTED CUSTOMER WIRE ENTRY
AND EXIT LOCATION

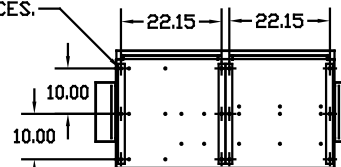

BOTTOM VIEW

**CUSTOMER INPUT/OUTPUT
CONNECTIONS:**
WIRE RANGE-TWO 350MCM-4
TIGHTENING TORQUE 275 IN-LB.

SYMBOL	TCI PART NUMBER
LR	KDRX43T
TR	KTR120C65HG
(20 KVAR) 6 PLACES.	KCAP20C6B
XFMR.	24389
Fu1,2,3	11175
Fu4,6	24390
Fu5	23977
CNT	19246

NO	REVISION	DATE	BY	TOLERANCES UNLESS OTHERWISE SPECIFIED	SCALE	DATE	BY	DATE	BY
				.XX ±.12					
				.XXX ±.06					
				FRACTIONAL ± 1/32					
				MILLAR ± 1/2"					

TCI 7878 N. 86th STREET
MILWAUKEE, WI 53224

HG400CW03STC, 400HP
600/3/60 UL TYPE 3R

DATE BY DSW DATE 02/18/09 DATE 103702DG
SCALE TO FIT

SHT. 1 OF 1