

HG200LW01STC

UNIT SPECIFICATIONS:					
KW	HARMONIC	VOLT	HZ	PHASE	FLA
200	5TH	400	50	3	370
ENCLOSURE		NEMA 1			
APPROX.WT. LBS.		950			

FOR SCHEMATIC SEE DWG# 27703-1

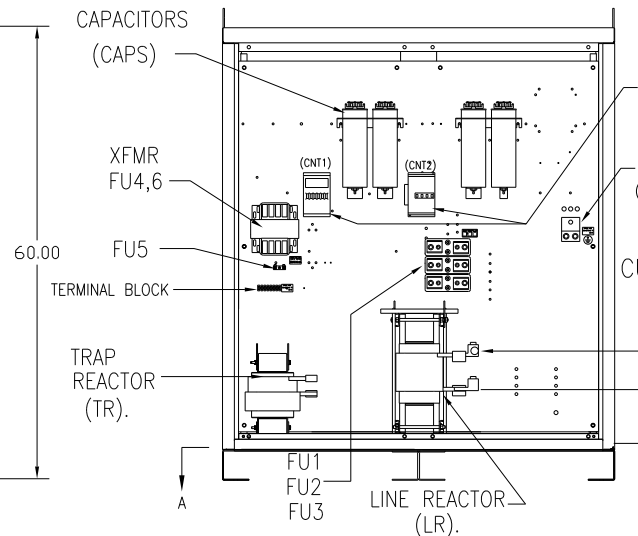
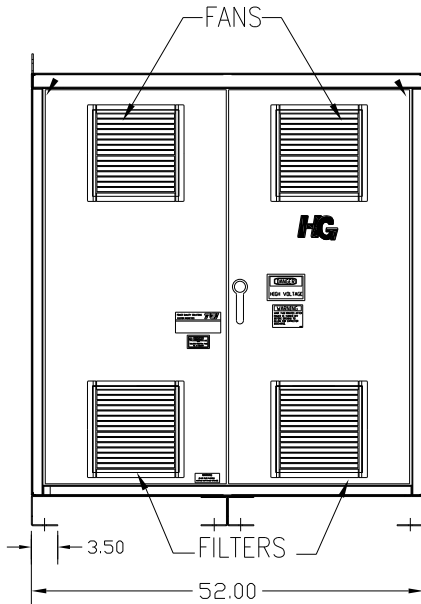
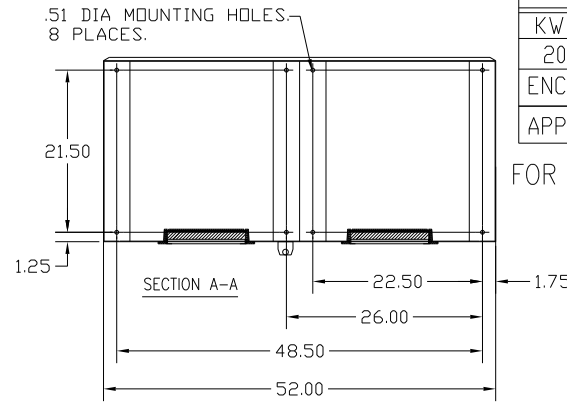
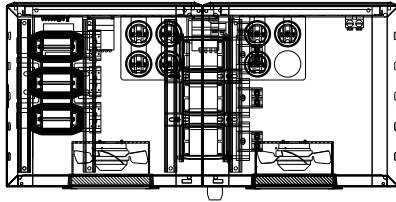
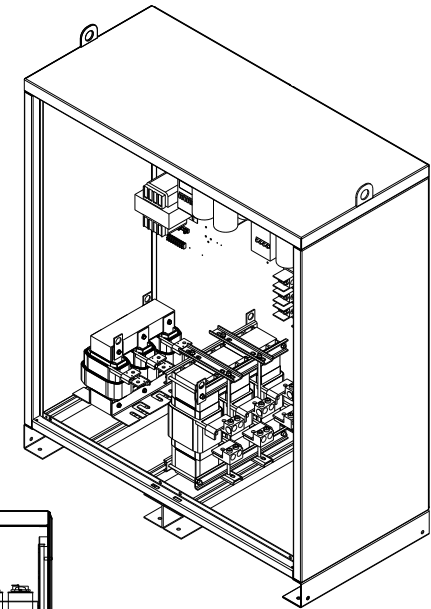

CUSTOMER CONNECTIONS:

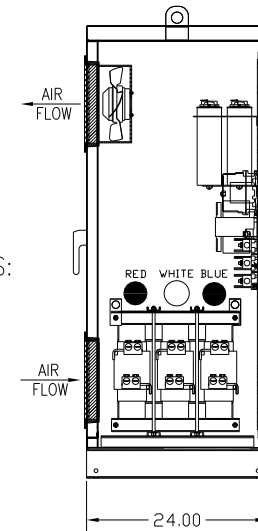
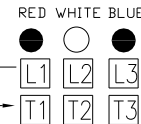

CUSTOMER CONNECTIONS:
WIRE RANGE-TWO 600MCM-2
TIGHTENING TORQUE 500 IN-LB.

GROUND LUG:
WIRE RANGE-TWO 600MCM-2
TIGHTENING TORQUE 500 IN-LB.

CUSTOMER IS RESPONSIBLE FOR INSTALLATION TO MEET ALL NATIONAL AND LOCAL ELECTRICAL CODES.

SYMBOL	TCI PART NUMBER
LR	KDRX32T
TR	KTR81L55HG
CAP1,-7 (20 KVAR)	KCAP20A6B
XFMR.	24389
Fu1, 2, 3	11175
Fu4,6	23820
Fu5	17569
CNT1	19246
CNT2	19245

NO	REVISION	DATE	BY	TOLERANCES (EXCEPT AS NOTED)
				DECIMAL
				.XX ± .03
				.XXX ± .01
				FRACTIONAL
				± 1/32
				ANGULAR
				± 1/2°

TCI 7878 N. 86th STREET
MILWAUKEE, WI 53224

TCI, HG7 Standard, 200kW
400/3/50, Type1, CNT.

DRN BY: DSW DATE: 3/22/2011 DWG NO: 104670DG
SCALE: -- APPRVD: B SHT.1 OF 1