

SEE DWG# 26964-2 FOR SCHEMATIC

CUSTOMER IS RESPONSIBLE FOR INSTALLATION TO MEET ALL NATIONAL AND LOCAL ELECTRICAL CODES.

NOTE: USE ONLY HUBS OR FITTINGS THAT COMPLY WITH UL514B FOR TYPE 3R ENCLOSURES.

UNIT SPECIFICATIONS:					
KVAR	HARMONIC	VOLT	HZ	PHASE	HP
120	5TH	600	60	3	400
ENCLOSURE		TYPE 3R- COLOR, WHITE			
APPROX.WT. LBS		966			

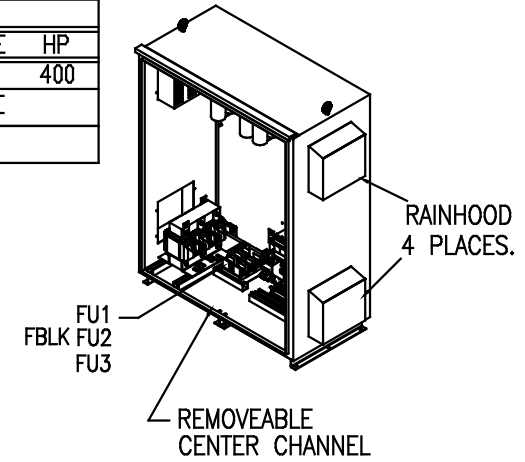
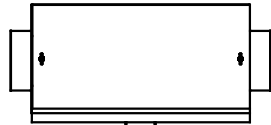
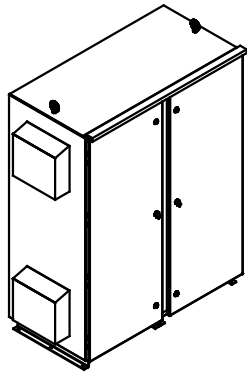

INSIDE DOOR

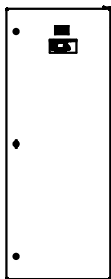

SIDE VIEW

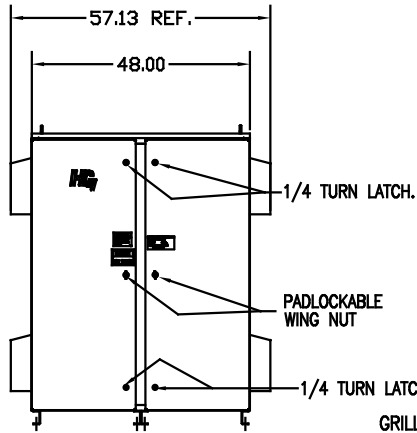
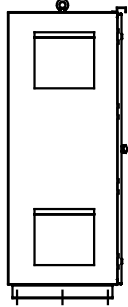

FRONT VIEW WITH DOORS.

FRONT VIEW WITHOUT DOORS

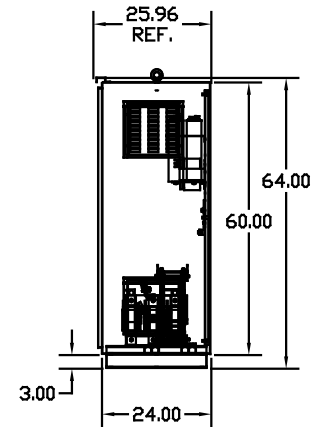
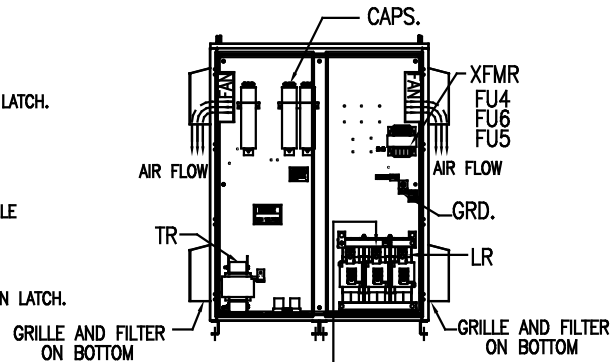

SIDE VIEW

SUGGESTED CUSTOMER WIRE ENTRY AND EXIT LOCATION

.50 DIA HOLES 12 PLACES.

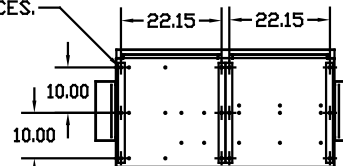

BOTTOM VIEW

**GROUND LUG:**  
WIRE RANGE-TWO 350MCM-4  
TIGHTENING TORQUE 275 IN.-LB.

**CUSTOMER INPUT/OUTPUT CONNECTIONS:**  
WIRE RANGE-TWO 350MCM-4  
TIGHTENING TORQUE 275 IN.-LB.

SYMBOL	TCI PART NUMBER
LR	KDRX43T
TR	KTR120C65HG
(20 KVAR) 6 PLACES.	KCAP20C6B
XFMR.	24389
Fu1,2,3	11175
Fu4,6	24390
Fu5	23977
CNT	19246

NO	REVISION	DATE	BY	TOLERANCES EXCEPT AS NOTED: DECIMAL .XX ±.12 .XXX±.06 FRACTIONAL ± 1/32 DIMENAL ± 1/2"	SCALE TO FIT	DATE 2/26/09	DATE 10/31/09	DATE 10/31/09

**TCI** 7878 N. 86th STREET MILWAUKEE, WI 53224

HG400CW03ST, 400HP  
600/3/60 UL TYPE 3R

DATE BY DSW DATE 2/26/09 DATE 10/31/09  
SCALE TO FIT

103647DG  
SHT.1 OF1